

# GUIDER

Puertas correderas de madera  
Wood Sliding Doors

Video de montaje  
Mounting video

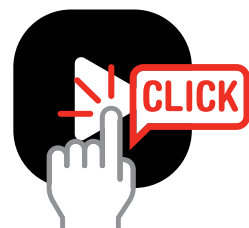

# 01 ÍNDICE

## INDEX

02 - INFORMACIÓN DE SEGURIDAD . . . . .	03
02 - SAFETY INFORMATION	
03 - EVALUACIÓN DE LOS RIESGOS DEL PRODUCTO . . . . .	05
03 - PRODUCT RISK ASSESSMENT	
04 - INFORMACIÓN GENERAL . . . . .	07
04 - GENERAL INFORMATION	
05 - HERRAMIENTAS NECESARIAS . . . . .	08
05 - REQUIRED TOOLS	
06 - ELEMENTOS DE LA INSTALACIÓN . . . . .	08
06 - ITEMS OF INSTALLATION	
07 - MECANIZACIÓN PANELES . . . . .	09
07 - PANEL FABRICATION	
08 - ESQUEMA COLOCACIÓN PLETINA TELESCÓPICA . . . . .	09
08 - TELESCOPIC PLATE INSTALLATION DIAGRAM	
09 - COLOCACIÓN PLETINA TELESCÓPICA . . . . .	09
09 - TELESCOPIC PLATE INSTALL	
10 - ESQUEMA COLOCACIÓN KBS . . . . .	10
12 - KBS INSTALLATION DIAGRAM	
11 - COLOCACIÓN KBS . . . . .	10
11 - KBS INSTALL	
12 - COLOCACIÓN DE LA PUERTA . . . . .	10
12 - DOOR MOUNTING	

# 02 INFORMACIÓN DE SEGURIDAD (ESP)

## SAFETY INFORMATION (ESP)

### INDICACIONES GENERALES

- Estas instrucciones solo son válidas para los sistemas KLEIN.
- Las medidas métricas son válidas. Las medidas en pulgadas son solo informativas.
- Los herrajes KLEIN no son adecuados para aplicaciones en espacios donde se utilicen productos químicos (p. ej. cloro) como piscinas interiores, saunas o piscinas de agua salada.
- Nunca mueva los paneles correderos a una velocidad superior a la de la marcha y detenga siempre la puerta manualmente antes de que alcance la posición final.
- No deslice las puertas con una fuerza excesiva.

### USO PREVISTO

- Herrajes para sistemas KLEIN.
- Solo para puertas correderas en interiores secos.
- Solo para apertura y cierre manual.

### GRUPO DESIGNADO

- Solo personal debidamente cualificado y especialmente formado está autorizado a montar los herrajes de vidrio y madera KLEIN.

### REQUISITOS DEL VIDRIO Y DE LOS DISPOSITIVOS DE FIJACIÓN

- La subestructura/pared debe ser capaz de soportar las cargas del sistema.
- Utilizar el par de apriete indicado.
- La zona de sujeción deber ser plana y sin recubrimiento.
- No utilizar vidrios con fracturas y/o bordes dañados.
- KLEIN exige el uso de vidrio que cumpla con los siguientes normas:

#### EUROPA:

- UNE EN 572-2:2012 Vidrio para la edificación. Productos básicos de vidrio de silicato sodocálcico. Parte 2: Vidrio plano.
- UNE EN 12150-1:2016 Vidrio para la edificación. Vidrio de silicato sodocálcico de seguridad templado térmicamente. Parte 1: Definición y descripción.
- UNE EN ISO 12543-1/6:2011 Vidrio para la edificación. Vidrio laminado y vidrio laminado de seguridad.

#### USA:

- ASTM C1036-16 Standard Specification for Flat Glass
  - ASTM C1048-12e1 Standard Specification for Heat-Strengthened and Fully Tempered Glass
  - ASTM C1172-14 Standard Specification for Laminated Architectural Flat Glass
- El rango de espesor admitido para el vidrio fijo y el vidrio de la puerta corredera en espesores de 1/2" va de 11.91mm a 12.70mm.

### INSTRUCCIONES DE SEGURIDAD

- Al fin de garantizar su seguridad, observe las indicaciones de las instrucciones de montaje del sistema de puertas correderas KLEIN.
- Lea las instrucciones antes de comenzar con el montaje.
- Usar únicamente componentes originales de KLEIN.
- Limpie la zona de sujeción con un producto de limpieza comercial estándar a base de alcohol antes de montar los herrajes de vidrio.
- El montaje incorrecto puede conllevar lesiones graves.
- La instalación requiere de mínimo dos personas.
- Debido a los riesgos indicados en el apartado 3, se requiere el correspondiente equipo de protección:
  - Guantes de seguridad.
  - Gafas de protección.
  - Casco de seguridad.
  - Botas de seguridad.



**Conserve las instrucciones.**

# INFORMACIÓN DE SEGURIDAD (EN)

## SAFETY INFORMATION (EN)

### GENERAL INFORMATION

- These mounting instructions are only valid for KLEIN systems.
- Metric measurements are valid. Inch measurements are only informative.
- KLEIN hardware is not suitable for use in areas where chemicals (e.g. chlorine) are used, such as indoor swimming pools, saunas or salt water pools.
- Never move the sliding panels faster than the travel speed and always stop the door manually before it reaches the end position.
- Do not slide doors with excessive force.

### EXPECTED USE

- Hardware for KLEIN systems.
- Only for sliding doors in dry interiors.
- Only for manual opening and closing.

### DESIGNATED GROUP

- Only qualified and specially trained personnel are authorised to fit KLEIN glass and wood hardware.

### REQUIREMENTS FOR GLASS AND FIXING DEVICES

- The substructure/wall must be capable of supporting system loads.
- Use the specified tightening torque.
- The clamping area must be flat and uncovered.
- Do not use glass with fractures and/or damaged edges.
- KLEIN requires the use of glass that complies with the following standards:

#### EUROPA:

- UNE EN 572-2:2012 Glass in building. Products Basic soda lime silicate glass products. Part 2: Flat glass.
- UNE EN 12150-1:2016 Glass in building. Thermally tempered safety soda-lime silicate glass. Part 1: Definition and description.
- UNE EN ISO 12543-1/6:2011 Glass in building. Glass laminated and laminated safety glass.

#### USA:

- ASTM C1036-16 Standard Specification for Flat Glass
  - ASTM C1048-12e1 Standard Specification for Heat-Strengthened and Fully Tempered Glass
  - ASTM C1172-14 Standard Specification for Laminated Architectural Flat Glass
- The permitted thickness range for fixed glass and sliding door glass in 1/2" thicknesses is from 11.91mm to 12.70mm.

### SAFETY INSTRUCTIONS

- To ensure your safety, please main the instructions in the installation instructions for the KLEIN sliding door system.
- Read the instructions before starting assembly.
- Use only original KLEIN components.
- Clean the clamping area with a standard commercial alcohol-based cleaning agent before mounting the glass fittings.
- Incorrect assembly can lead to serious injury.
- The installation requires a minimum of two people.
- Due to the risks listed in section 3, appropriate protective gear is required:
  - Safety gloves.
  - Protective goggles.
  - Safety helmet.
  - Safety boots.



**Keep the instructions.**

# 03 EVALUACIÓN DE LOS RIESGOS DEL PRODUCTO (ESP) PRODUCT RISK ASSESSMENT (ESP)

Probabilidad de ocurrencia						
Frecuente	5	5	10	15	20	25
Probable	4	4	8	12	16	20
Ocasionalmente	3	3	6	9	12	15
Remoto	2	2	4	6	8	10
Imposible / Improbable	1	1	2	3	4	5
		1	2	3	4	5
	Gravedad	Daños en el producto	Lesiones leves o daños materiales	Lesiones graves o daños materiales importantes	Lesión grave	Peligrosidad para la vida

	Importante (10 - 25)
	Revisión para determinar si el riesgo es ALARP (4 -9)
	Aceptable (1 - 3)

Riesgos de montaje	Probabilidad	Impacto	Resultado	Prevención	Probabilidad	Impacto	Resultado final
Cortes por los bordes del perfil	3 (Ocasionalmente)	2 (Lesiones leves o daños materiales)	6	Se requieren guantes para el montaje. El producto debe ser instalado únicamente por personal autorizado.	1 (Imposible)	2 (Lesiones leves o daños materiales)	3
Golpes por el perfil	3 (Ocasionalmente)	3 (Lesiones graves o daños materiales importantes)	6	El perfil debe ser fijado por un número suficiente de trabajadores de acuerdo con la longitud del riel. El producto debe ser instalado únicamente por personal autorizado.	1 (Imposible)	3 (Lesiones graves o daños importantes a la propiedad)	3
Caída del perfil	2 (Remoto)	3 (Lesiones graves o daños materiales importantes)	6	El perfil debe fijarse a una estructura nivelada y suficientemente sólida. El producto debe ser instalado únicamente por personal autorizado.	1 (Imposible)	3 (Lesiones graves o daños importantes a la propiedad)	3
Caída de la puerta	2 (Remoto)	3 (Lesiones graves o daños materiales importantes)	6	Los topes del interior del perfil deben fijarse correctamente según las instrucciones de montaje. El producto debe ser instalado únicamente por personal autorizado.	1 (Imposible)	3 (Lesiones graves o daños importantes a la propiedad)	3

Mounting Risk	Probability	Impact	Result	Prevention	Probability	Impact	Final Result
Golpeo por la puerta	3 (Ocasionalmente)	2 (Lesiones leves o daños materiales)	6	Nunca mueva los paneles deslizantes a una velocidad superior a la de la marcha. Detenga siempre la puerta manualmente antes de que llegue a la posición final.	1 (Imposible)	2 (Lesiones leves o daños materiales)	2

# EVALUACIÓN DE LOS RIESGOS DEL PRODUCTO (EN)

## PRODUCT RISK ASSESSMENT (EN)

Likelihood of occurrence						
Frequent	5	5	10	15	20	25
Probable	4	4	8	12	16	20
Occasional	3	3	6	9	12	15
Remote	2	2	4	6	8	10
Impossible / Improbable	1	1	2	3	4	5
		1	2	3	4	5
	Severity	Product damage	Minor injury or Property Damage	Serious injury or major property damage	Grievous injury	Life threatening

	Significant (10 - 25)
	review to determine if risk is ALARP (4 -9)
	Acceptable (1 - 3)

Mounting Risk	Probability	Impact	Result	Prevention	Probability	Impact	Final Result
Cuts by track edges	3 (Occasional)	2 (Minor injury or porperty damage)	6	Gloves are required for mounting. The product must be installed by authorized personnel only.	1 (Impossible)	2 (Minor injury or porperty damage)	3
Hits by track	3 (Occasional)	3 (Serious injury or major property damage)	6	The track must be fixed by a sufficient number of workers according to the lenght of the track. The product must be installed by authorized personnel only.	1 (Impossible)	3 (Serious injury or major porperty damage)	3
Fall of the track	2 (Remote)	3 (Serious injury or major property damage)	6	The track must be fixed to a levelled and solid enough structure. The product must be installed by authorized personnel only.	1 (Impossible)	3 (Serious injury or major porperty damage)	3
Fall of the door	2 (Remote)	3 (Serious injury or major property damage)	6	Stoppers inside of the track must be fixed correctly according to the mounting instructions. The product must be installed by authorized personnel only.	1 (Impossible)	3 (Serious injury or major porperty damage)	3

Mounting Risk	Probability	Impact	Result	Prevention	Probability	Impact	Final Result
Door hitting	3 (Occasional)	2 (Minor injury or porperty damage)	6	Never move sliding panels faster than walking speed. Always stop the door manually before it reaches end position.	1 (Impossible)	2 (Minor injury or porperty damage)	2

# 04 INFORMACIÓN GENERAL GENERAL INFORMATION

2 hojas / 2 doors



3 hojas / 3 doors



Max. 150 kg  
Max. 330 lbs



25 mm - 50 mm  
1" - 2"

Cantidad de puertas = X  
Number of doors = X

Cantidad de KITS = X - 1  
Number of KITS = X - 1



GUIDER  
GUIDER

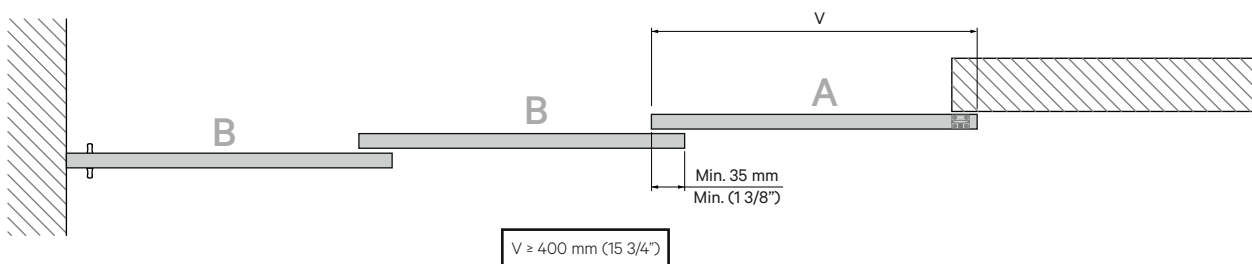

GUIDER KBS  
GUIDER KBS

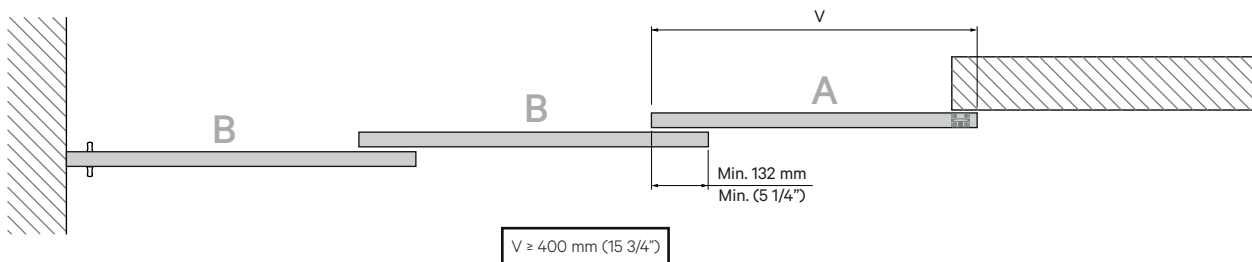

FÓRMULA VIABILIDAD  
FEASIBILITY FORMULA

DISTANCIA ENTRE PERFILES  
DISTANCE BETWEEN PROFILES

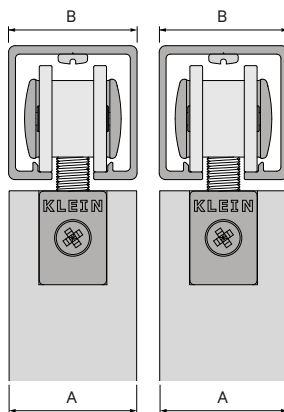
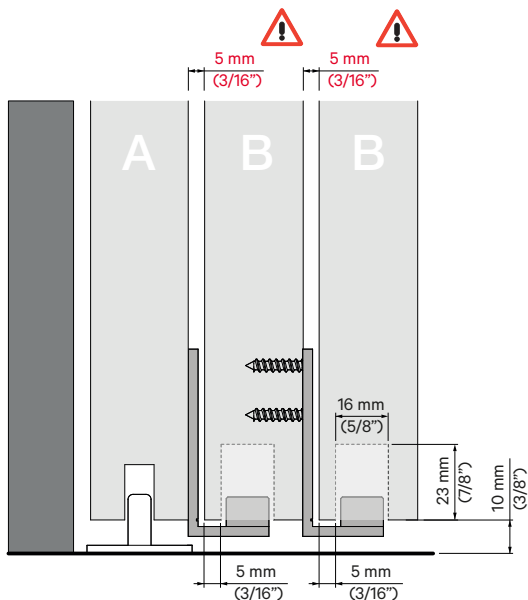

**A + 5 mm (3/16") ≥ B**

Si se cumple esta fórmula es posible instalar el sistema.  
This formula must be fulfilled to install de system.

# 05 HERRAMIENTAS NECESARIAS REQUIRED TOOLS



1. Lápiz / Pencil

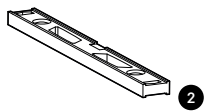

2. Nivel/ Level



3. Destornillador PZ #2 / Screwdriver PZ #2  
Destornillador TX #10 / Screwdriver TX

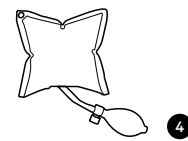

4. Calzo / Shim  
(Altura mínima 10 mm)  
(Minimum height 3/8")

# 06 ELEMENTOS DE LA INSTALACIÓN ITEMS OF INSTALLATION



## JUEGO DE ACCESORIOS GUIDER SET OF ACCESORIES GUIDER

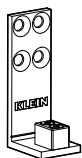

x 1 Pletina telescópica  
Telescopic plate



x 1 QR  
QR



x 4 Tornillos pletina Ø4 x 20 mm  
Screws plate Ø3/16" x 13/16"



## JUEGO DE ACCESORIOS GUIDER KBS SET OF ACCESORIES GUIDER KBS

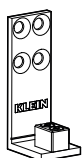

x 1 Pletina telescópica  
Telescopic plate



x 2 Anclajes KBS  
KBS anchor pieces



x 4 Tornillos pletina Ø4 x 20 mm  
Screws plate Ø3/16" x 13/16"



x 2 Tornillos anclajes KBS  
Ø3 x 14 mm  
Screws anchor pieces  
Ø1/8" x 9/16"



x 1 KBS  
KBS



x 2 Tornillos KBS Ø4 x 30 mm  
Screws KBS Ø3/16" x 1 3/16"



x 1 QR  
QR



# 07 MECANIZACIÓN PANELES PANEL MACHINING

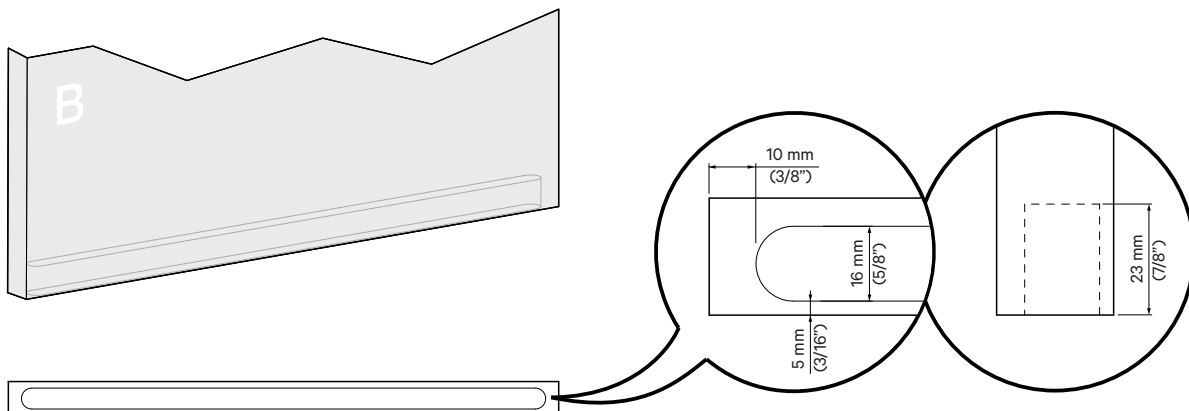

# 08 ESQUEMA COLOCACIÓN PLETINA TELESCÓPICA TELESCOPIC PLATE INSTALLATION DIAGRAM

 Pletina telescópica  
Telescopic plate 

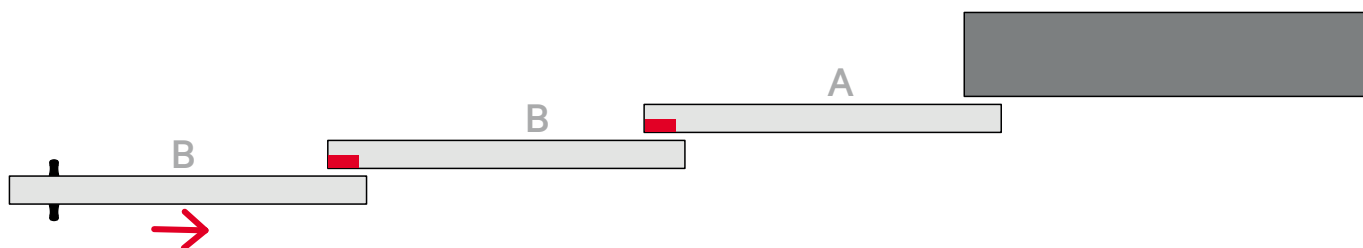

# 09 COLOCACIÓN PLETINA TELESCÓPICA TELESCOPIC PLATE INSTALL

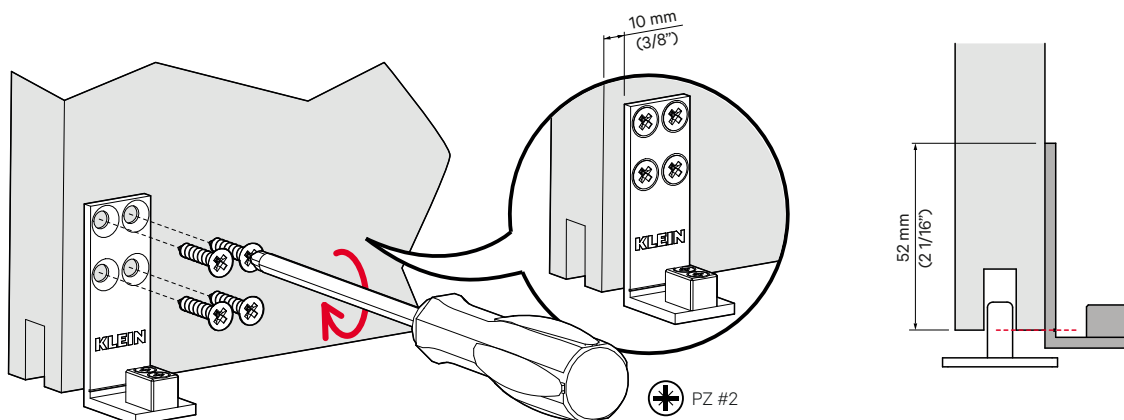

# 10 ESQUEMA COLOCACIÓN KBS KBS INSTALLATION DIAGRAM

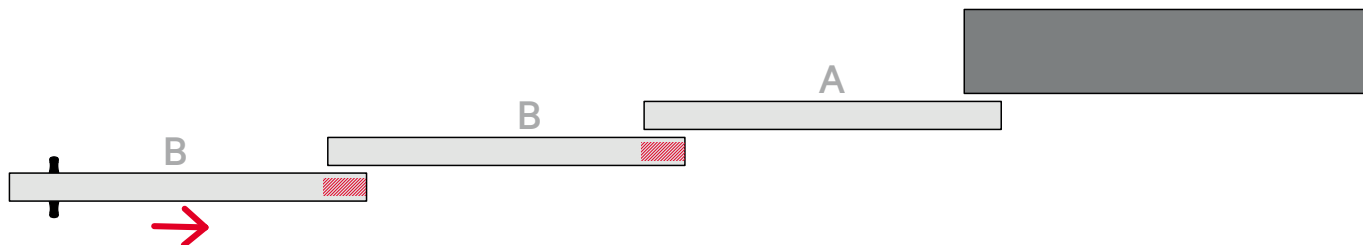

Solo hacer este paso si tienes el JGO ACC GUIDER KBS  
Only do this step if you have the SET OF ACC GUIDER KBS

# 11 COLOCACIÓN KBS KBS INSTALL

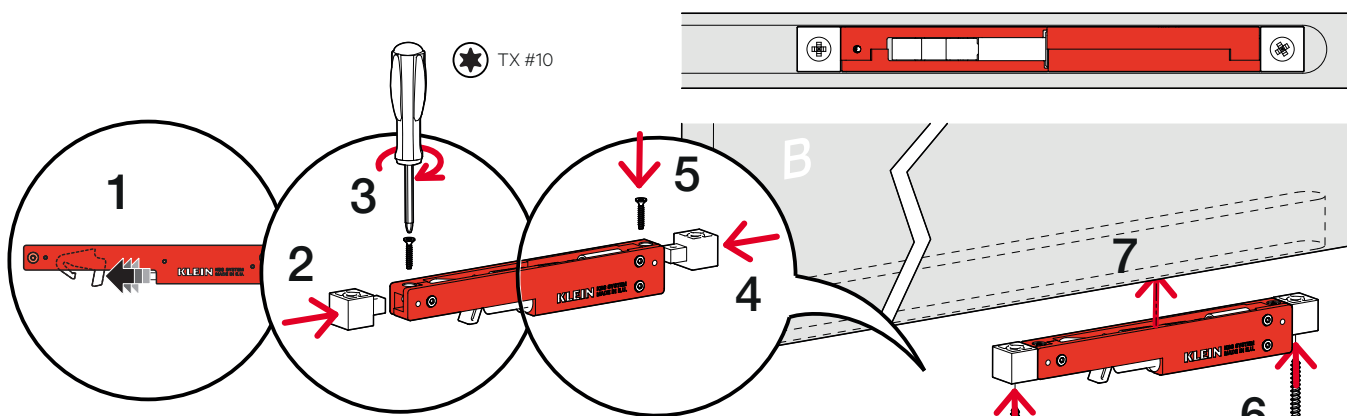

Solo hacer este paso si tienes el JGO ACC GUIDER KBS  
Only do this step if you have the SET OF ACC GUIDER KBS

# 12 COLOCACIÓN DE LA PUERTA DOOR MOUNTING

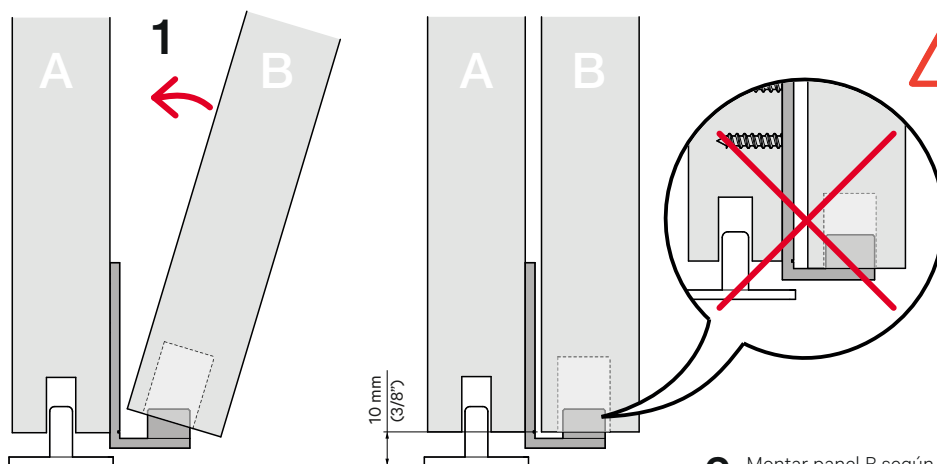

**2** Montar panel B según hoja de instrucciones del sistema corredero.  
Install panel B following the mounting instructions of the sliding system.

**Limited Warranty.**

(1) KLEIN IBERICA, S.A.U. & KLEIN USA, Inc. warrants to the immediate customer only that the delivered goods are free of original material defects and defects in workmanship for a period of five years from date of receipt by the customer. All warranty claims are subject to inspection by KLEIN IBERICA, S.A.U. & KLEIN USA, Inc. prior to KLEIN IBERICA, S.A.U. & KLEIN USA, Inc. providing a remedy for the warranty claim.

(2) Excluded from this warranty are products, or parts of them, subject to wear through use, and products which have not been used in accordance with their technical characteristics and for purposes for which they have not been designed, being understood that the products sold by KLEIN IBERICA, S.A.U. & KLEIN USA, Inc. are designed exclusively for the enclosure of spaces, with the enclosing running precisely in the longitudinal sense.

(3) Also excluded from this warranty are those products in which the limits expressed in the product documentation have been exceeded for weights and dimension supported by the product, and/or recommendations for the qualities of the material to which the products sold by KLEIN IBERICA, S.A.U. & KLEIN USA, Inc. are fixed have not been complied with.

(4) KLEIN IBERICA, S.A.U. & KLEIN USA, Inc. makes no warranty with respect to the following: a) materials not manufactured by KLEIN IBERICA, S.A.U. & KLEIN USA, Inc. or any other group companies, the use of which is suggested by KLEIN IBERICA, S.A.U. & KLEIN USA, Inc. or any other group companies general recommendations, application or installation procedures or otherwise; b) All display items sold by KLEIN IBERICA, S.A.U. & KLEIN USA, Inc. to the Customer.

(5) Warranties are exclusive, and in lieu of all other warranties, express or implied, written or oral, including but not limited to, any implied warranty of merchantability or fitness for any particular purpose. KLEIN IBERICA, S.A.U. & KLEIN USA, Inc. does not assume, nor authorize any representative or other person to assume for it, any obligation or liability other than as expressly set forth herein.

(6) For the warranty to take effect, the defective product must be sent with the voucher or purchase invoice to the Company, which will then process to repair or replace the product, at its choice.

(7) KLEIN IBERICA, S.A.U. & KLEIN USA, Inc. will accept no other responsibility than the repair or replacement of the product and only for the purchaser of the product, so the rights granted by this warranty may not be assigned to third parties.

**Extent of liability.**

(1) In case of a breach of contractual obligations, defective deliveries, tortuous acts or producers liability, KLEIN IBERICA, S.A.U. & KLEIN USA, Inc. shall only be obliged to compensate damages or expenses –subject to any other contractual or statutory conditions for liability– if it acted intentionally or with gross negligence or in cases of minor negligence, if such negligence results in the breach of an essential contractual duty (a duty the breach of which puts the fulfillment of the purpose of the contract at risk). The liability of KLEIN IBERICA, S.A.U. & KLEIN USA, Inc. shall be limited to typical damages which are foreseeable at the time of the conclusion of the contract.

(2) The liability of KLEIN IBERICA, S.A.U. & KLEIN USA, Inc. for losses caused by late delivery due to minor negligence shall be limited to 5% of the agreed purchase price.

(3) The exclusions and limitations of liability in sections (1) – (2) shall not apply in cases where KLEIN IBERICA, S.A.U. & KLEIN USA, Inc. has maliciously failed to disclose a defect, in case of damages resulting from death, injury to health or physical injury where the laws on product liability impose overriding liabilities which cannot be excluded.

(4) The limitation period for claims against KLEIN IBERICA, S.A.U. & KLEIN USA, Inc. –based on whatever legal ground- is 12 months from the date of delivery to the customer and in case of tortuous claims 12 months from the date the customer becomes aware or would have become aware of the grounds giving rise to a claim and the liable person had he not been grossly negligent. The provisions in this section (4) shall neither apply in cases of intentional or gross negligent breaches of duty nor shall they apply in cases referred to in section 13. (3).

**Force Majeure.**

(1) KLEIN IBERICA, S.A.U. & KLEIN USA, Inc. shall not be liable for any default or delay in the production or delivery of all or any goods resulting either directly or indirectly from: a) Accidents to, breakdowns, or mechanical failure of KLEIN IBERICA, S.A.U. & KLEIN USA, Inc. or any other group companies' plant, machinery or equipment, strikes or other labour troubles, labour shortages, fire, flood, wars, acts of the public enemy, acts of God, delays of suppliers, delays in transportation or lack of transportation facilities, embargos, shortages or reductions of energy sources, priorities, allocations, limitations, restrictions or other acts required or requested by federal, state or local governments or any other bureau or agency thereof; b) Any action beyond the control of the Company.

(2) In no event shall KLEIN IBERICA, S.A.U. & KLEIN USA, Inc. or any other group companies be liable for any consequential, special, or contingent damages arising out of KLEIN IBERICA, S.A.U. & KLEIN USA, Inc. or any other group companies default or delay in filling the customer's order.

**Industrial Property Rights, Copyrights.**

(1) Industrial property rights and copyrights to any goods or material of KLEIN IBERICA, S.A.U. & KLEIN USA, Inc. shall remain exclusively the proprietary of the Company. (2) In the event of claims against the customer because of breach of an industrial property right or a copyright in using the Company's deliveries or services, KLEIN IBERICA, S.A.U. & KLEIN USA, Inc. shall be responsible to obtain the right for the customer to continue using such deliveries or services, provided that the customer gives immediate written notice of such third-party claims and KLEIN IBERICA, S.A.U. & KLEIN USA, Inc. rights to take all appropriate defensive and out-of-court actions are reserved. If, despite such actions, it proves impossible to continue using the Company's deliveries or services under reasonable economic conditions, it shall be understood as agreed that KLEIN IBERICA, S.A.U. & KLEIN USA, Inc. may, at its discretion, modify or replace the particular delivery or service for removal of a legal deficiency, or reship such delivery or service with refunding of the sales price previously paid to KLEIN IBERICA, S.A.U. & KLEIN USA, Inc. less a certain deduction to account for the age of the delivery or service in question.

(2) The customer shall have no further claims alleging infringement of industrial property or copyrights, if KLEIN IBERICA, S.A.U. & KLEIN USA, Inc. has not either violated essential contractual duties or has intentionally or grossly negligently breached contractual duties. KLEIN IBERICA, S.A.U. & KLEIN USA, Inc. shall have no liability where breaches of rights are caused by exploiting Company's deliveries or services in any other way than quoted by KLEIN IBERICA, S.A.U. & KLEIN USA, Inc. or by operating these together with any other than Company's deliveries or services.



# KLEIN

KLEIN EUROPE - GLOBAL HEADQUARTER  
Pol. Ind. Can Cuyas. N-150 Km.1  
08110 Montcada i Reixac (Barcelona)  
Tel.: + 34 935 760 101

Fax: + 34 935 760 109  
klein@klein.es  
www.klein.es

KLEIN USA, INC - US HEADQUARTER  
1 Madison Street  
East Rutherford, NJ 07073  
Phone: 973 246 8181

Fax: 973 246 8362  
info@klein-usa.com  
www.klein-usa.com

Follow us on social media  
Síguenos en redes

