

SLID PAR & FOLD

- Ficha técnica / Brochure **SLID PAR**
- Ficha técnica / Brochure **SLID FOLD**

Sistema de puertas plegables
Folding doors system
Système de portes pliables
Falttürsystem

SLID PAR

Interiorismo Madera
Interior Design Wood
Décoration d'Intérieur Bois
Raumgestaltung Holz



SLID PAR



ESP

SLID PAR es un sistema para puertas plegables interiores diseñado para dos paneles plegables, libres de perfiles en el suelo. Ofrece una máxima integración del perfil en el falso techo en su versión empotrada.

- Nuevas bisagras invisibles, integradas en el juego de accesorios para disponer de todos los elementos de la instalación.
- Dos tipos de plegado: central y lateral, para cumplir con cualquier reto arquitectónico.
- Perfil Top empotrable para instalaciones invisibles.
- Funcionamiento óptimo gracias al sistema de pivotación.
- Sistema Retrac: facilita el montaje del conjunto.
- Perfil de aluminio anodizado Silver.
- Dos paneles, de hasta 75 kg cada uno.
- Espesor de paneles a partir de 35 mm.
- 5 años de garantía.

Sistemas testados hasta 100.000 ciclos según la norma EN1527.

FRA

SLID PAR est un système pour portes pliantes intérieures conçu pour deux panneaux pliants, sans rail au sol. Dans sa version encastrée, il offre une intégration maximale du profil dans le faux plafond.

- Nouvelles charnières invisibles, intégrées dans le set d'accessoires pour disposer de tous les éléments d'installation.
- Deux types de pliage: central et latéral, pour répondre à tout défi architectural.
- Profil Top encastrable pour installations invisibles.
- Fonctionnement optimal grâce au système de pivotement.
- Système Retrac: facilite le montage de l'ensemble.
- Profil en aluminium anodisé Silver.
- Deux panneaux, de 75 kg chacun.
- Épaisseur du plateau à partir de 35 mm.
- Garantie KLEIN® 5 ans.

Systèmes testés jusqu'à 100.000 cycles selon la norme EN1527.

ENG

SLID PAR is an interior folding door system designed to fit in openings through two folding panels, with no floor track. It allows maximum integration into the silhouette of false ceilings.

- New invisible hinges, integrated in the accessory set to have all installation elements.
- Two types of folding: central and side, to meet any architectural challenge.
- Recessed track (Top) for invisible installations.
- Optimum functionality through pivot system.
- Retrac system facilitates the installation of the set.
- Anodized silver aluminum surface.
- 2 panels, maximum of 75 kg each.
- Panel thickness from 35 mm.
- 5 year warranty.

Systems tested up to 100.000 cycles as per standard EN1527.

DEU

SLID PAR ist ein Falttür-System in Innenräumen, das für zwei Faltpaneele ohne Profile auf dem Boden entworfen wurde. In der Einbauausführung integriert sich das Profil maximal in die Zwischendecke.

- Neue unsichtbare Scharniere, die in den Zubehörsatz integriert sind, um alle Installationselemente zu haben.
- Twee soorten vouwen: centraal en opzij, om elke architecturale uitdaging aan te gaan.
- Einbaubares Profil Top für den unsichtbaren Einbau.
- Optimale Funktion durch das Schwenksystem.
- Das System Retrac vereinfacht die Montage der Baugruppe.
- Profil aus eloxiertem Aluminium in "Silver".
- Zwei Paneele, jedes mit einem Gewicht von 75 kg.
- Pfannendicke ab 35 mm.
- Garantie von KLEIN® 5 Jahre.

Systeme gemäß der Norm EN1527 bis 100.000 Zyklen getestet.

SLID PAR

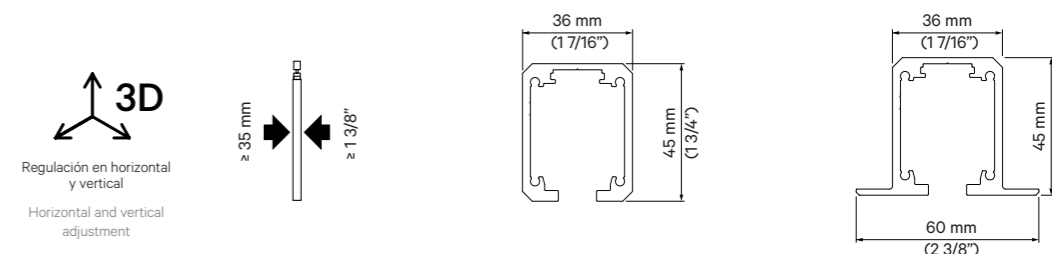

SLID PAR LATERAL

PLEGADO LATERAL/ SIDE FOLDING
SEITLICH FALTUNG / PLIAGE LATÉRAL



Roller situado en el panel marcado en rojo/ Roller located in the panel marked in red

PLEGADO CENTRAL/ CENTRAL FOLDING
ZENTRAL FALTUNG / PLIAGE CENTRAL

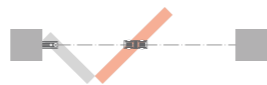

INSTALACIÓN VISTA/
EXPOSED INSTALLATION

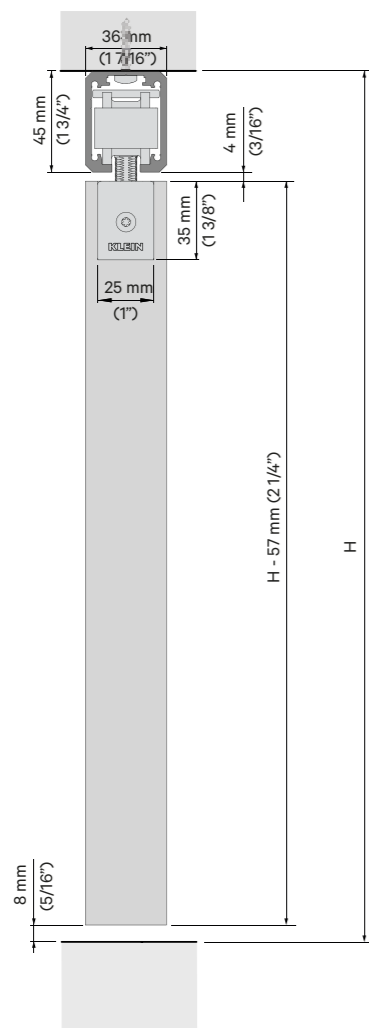

INSTALACIÓN EMPOTRADA
RECESSED INSTALLATION

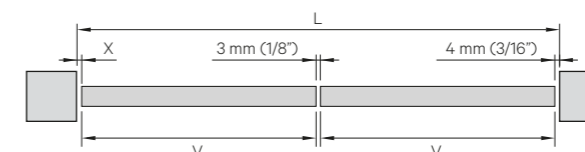
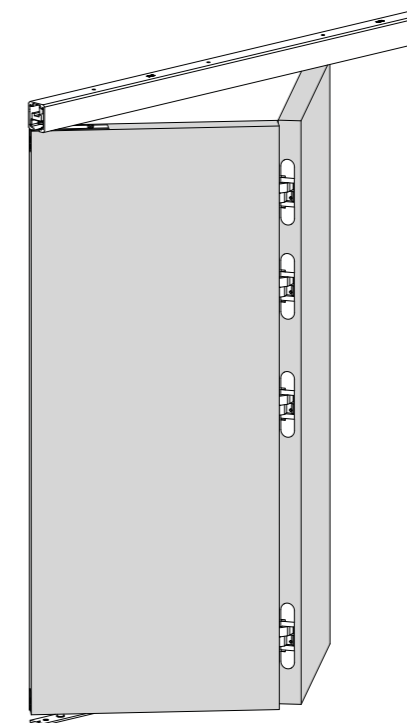
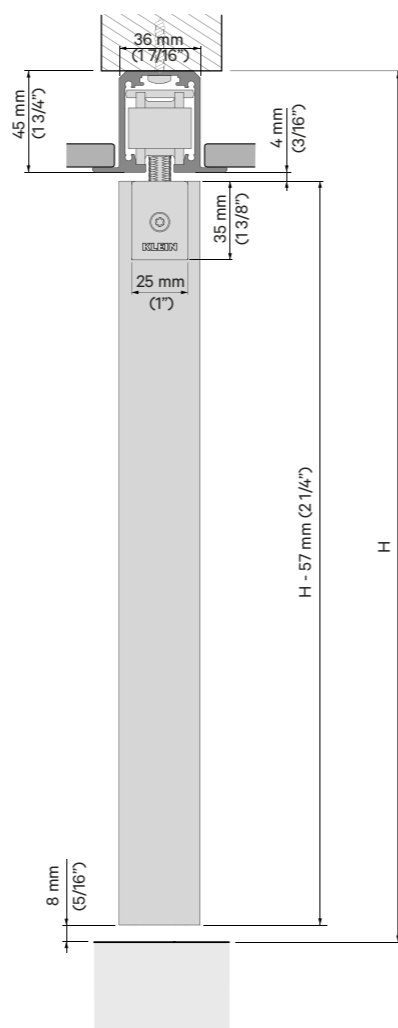

$$\frac{L - X - 4 \text{ mm } (3/16'') - 3 \text{ mm } (1/8'')}{2}$$

V Min. = 350 mm (13 13/16'')

V Max. = 1250 mm (49 3/16'')

Espesor Puerta (Panel Thickness)	X
35 mm (1 3/8'')	5 mm (3/16'')
40 mm (1 9/16'')	6 mm (1/4'')
45 mm (1 3/4'')	7 mm (9/32'')
50 mm (2'')	8 mm (5/16'')

SLID PAR CENTRAL

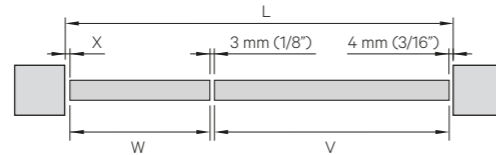
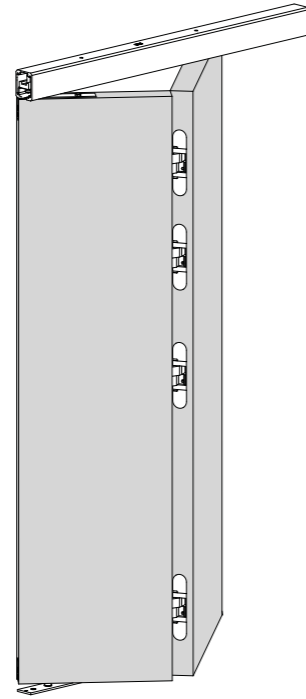

$$V = \frac{L - (51 \text{ mm} + X) - 3 \text{ mm}}{1,5}$$

$$W = \frac{V}{2} + 51 \text{ mm}$$

$$V = \frac{L - (2'' + X) - 1/8''}{1,5}$$

$$W = \frac{V}{2} + 2''$$

V Min. = 350 mm (13 13/16")

V Max. = 1250 mm (49 3/16")

Esesor Puerta (Panel Thickness)	X
35 mm (1 3/8")	5 mm (3/16")
40 mm (1 9/16")	6 mm (1/4")
45 mm (1 3/4")	7 mm (9/32")
50 mm (2")	8 mm (5/16")

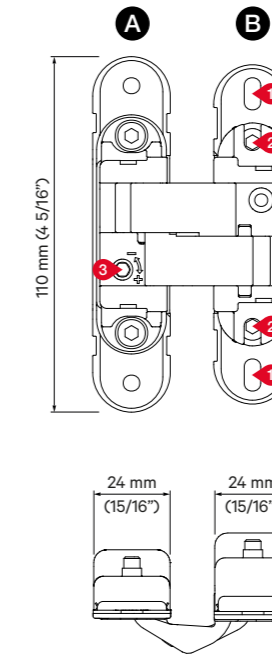

Regulación 3D

- 1 Vertical: ± 2,5 mm (1/8")
- 2 Horizontal: ± 1,5 mm (1/16")
- 3 Profundidad: ± 1 mm (3/64")

MECANIZACIÓN DEL PANEL/
PANEL FABRICATION

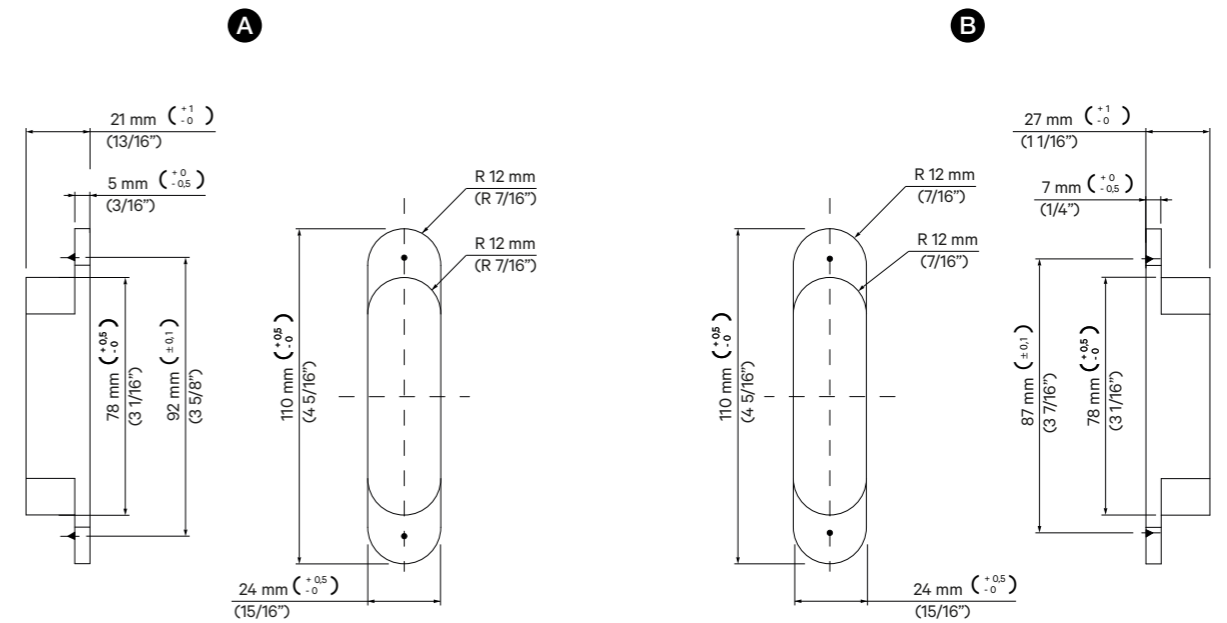

ESP

SLID PAR CENTRAL			
Ref.	Descripción	U.	Img.
2759	KIT SLID PAR 150 CENTRAL SILVER (1,80m)	1	A

SLID PAR TOP CENTRAL			
Ref.	Descripción	U.	Img.
2761	KIT SLID PAR 150 TOP CENTRAL SILVER (1,80m)	1	B

SLID PAR LATERAL			
Ref.	Descripción	U.	Img.
2741	KIT SLID PAR 150 LATERAL SILVER (1,8m)	1	C
2745	KIT SLID PAR 150 LATERAL SILVER (2,4m)	1	C

SLID PAR TOP LATERAL			
Ref.	Descripción	U.	Img.
2750	KIT SLID PAR 150 TOP LATERAL SILVER (1,8m)	1	D
2751	KIT SLID PAR 150 TOP LATERAL SILVER (2,4m)	1	D

SLID PAR CENTRAL DUO			
Ref.	Descripción	U.	Img.
3087	KIT SLID PAR 150 DUO CENTRAL SILVER (1,80m)	1	E
3088	KIT SLID PAR 150 DUO CENTRAL SILVER (2,40m)	1	E
3089	KIT SLID PAR 150 DUO CENTRAL SILVER (2,80m)	1	E
3090	KIT SLID PAR 150 DUO CENTRAL SILVER (3,40m)	1	E

SLID PAR TOP CENTRAL DUO			
Ref.	Descripción	U.	Img.
3091	KIT SLID PAR 150 TOP DUO CENTRAL SILVER (1,80m)	1	F
3092	KIT SLID PAR 150 TOP DUO CENTRAL SILVER (2,40m)	1	F
3093	KIT SLID PAR 150 TOP DUO CENTRAL SILVER (2,80m)	1	F
3094	KIT SLID PAR 150 TOP DUO CENTRAL SILVER (3,40m)	1	F

SLID PAR LATERAL DUO			
Ref.	Descripción	U.	Img.
2749	KIT SLID PAR 150 DUO LATERAL SILVER (4,00m)	1	G

SLID PAR TOP LATERAL DUO			
Ref.	Descripción	U.	Img.
2755	KIT SLID PAR 150 TOP DUO LATERAL SILVER (4,00)	1	H

ENG

SLID PAR CENTRAL			
Ref.	Description	Units	Img.
2759	KIT SLID PAR 150 CENTRAL SILVER (1,80m)	1	A

SLID PAR TOP CENTRAL			
Ref.	Description	Units	Img.
2761	KIT SLID PAR 150 TOP CENTRAL SILVER (1,80m)	1	B

SLID PAR LATERAL			
Ref.	Description	Units	Img.
2741	KIT SLID PAR 150 LATERAL SILVER (1,8m)	1	C
2745	KIT SLID PAR 150 LATERAL SILVER (2,4m)	1	C

SLID PAR LATERAL TOP			
Ref.	Description	Units	Img.
2750	KIT SLID PAR 150 TOP LATERAL SILVER (1,8m)	1	D
2751	KIT SLID PAR 150 TOP LATERAL SILVER (2,4m)	1	D

SLID PAR DUO CENTRAL			
Ref.	Description	Units	Img.
3087	KIT SLID PAR 150 DUO CENTRAL SILVER (1,80m)	1	E
3088	KIT SLID PAR 150 DUO CENTRAL SILVER (2,40m)	1	E
3089	KIT SLID PAR 150 DUO CENTRAL SILVER (2,80m)	1	E
3090	KIT SLID PAR 150 DUO CENTRAL SILVER (3,40m)	1	E

SLID PAR TOP DUO CENTRAL			
Ref.	Description	Units	Img.
3091	KIT SLID PAR 150 TOP DUO CENTRAL SILVER (1,80m)	1	F
3092	KIT SLID PAR 150 TOP DUO CENTRAL SILVER (2,40m)	1	F
3093	KIT SLID PAR 150 TOP DUO CENTRAL SILVER (2,80m)	1	F
3094	KIT SLID PAR 150 TOP DUO CENTRAL SILVER (3,40m)	1	F

SLID PAR DUO LATERAL			
Ref.	Description	Units	Img.
2749	KIT SLID PAR 150 DUO LATERAL SILVER (4,00m)	1	F

SLID PAR TOP DUO LATERAL			
Ref.	Description	Units	Img.
2755	KIT SLID PAR 150 TOP DUO LATERAL SILVER (4,00)	1	H

FRA

SLID PAR CENTRAL			
Ref.	Description	Unités	Img.
2759	KIT SLID PAR 150 CENTRAL SILVER (1,80m)	1	A

SLID PAR TOP CENTRAL			
Ref.	Description	Unités	Img.
2761	KIT SLID PAR 150 TOP CENTRAL SILVER (1,80m)	1	B

SLID PAR LATERAL			
Ref.	Description	Unités	Img.
2741	KIT SLID PAR 150 LATERAL SILVER (1,8m)	1	C
2745	KIT SLID PAR 150 LATERAL SILVER (2,4m)	1	C
2698	KIT SLID PAR 150 LATERAL SILVER (2,80m)	1	C

SLID PAR TOP LATERAL			
Ref.	Description	Unités	Img.
2750	KIT SLID PAR 150 TOP LATERAL SILVER (1,8m)	1	D
2751	KIT SLID PAR 150 TOP LATERAL SILVER (2,4m)	1	D

SLID PAR DUO CENTRAL			
Ref.	Description	Unités	Img.
3087	KIT SLID PAR 150 DUO CENTRAL SILVER (1,80m)	1	E
3088	KIT SLID PAR 150 DUO CENTRAL SILVER (2,40m)	1	E
3089	KIT SLID PAR 150 DUO CENTRAL SILVER (2,80m)	1	E
3090	KIT SLID PAR 150 DUO CENTRAL SILVER (3,40m)	1	E

SLID PAR TOP DUO CENTRAL			
Ref.	Description	Unités	Img.
3091	KIT SLID PAR 150 TOP DUO CENTRAL SILVER (1,80m)	1	F
3092	KIT SLID PAR 150 TOP DUO CENTRAL SILVER (2,40m)	1	F
3093	KIT SLID PAR 150 TOP DUO CENTRAL SILVER (2,80m)	1	F
3094	KIT SLID PAR 150 TOP DUO CENTRAL SILVER (3,40m)	1	F

SLID PAR DUO LATERAL			
Ref.	Description	Unités	Img.
2749	KIT SLID PAR 150 DUO LATERAL SILVER (4,00m)	1	F

SLID PAR TOP DUO LATERAL			
Ref.	Description	Unités	Img.
2755	KIT SLID PAR 150 TOP DUO LATERAL SILVER (4,00)	1	H

DEU

SLID PAR CENTRAL			
Ref.	Beschreibung	Ein.	Bild.
2759	KIT SLID PAR 150 CENTRAL SILVER (1,80m)	1	A

SLID PAR TOP CENTRAL			
Ref.	Beschreibung	Ein.	Bild.
2761	KIT SLID PAR 150 TOP CENTRAL SILVER (1,80m)	1	B

SLID PAR LATERAL			
Ref.	Beschreibung	Ein.	Bild.
2741	KIT SLID PAR 150 LATERAL SILVER (1,8m)	1	C
2745	KIT SLID PAR 150 LATERAL SILVER (2,4m)	1	C

SLID PAR TOP LATERAL			
Ref.	Beschreibung	Ein.	Bild.
2750	KIT SLID PAR 150 TOP LATERAL SILVER (1,8m)	1	D
2751	KIT SLID PAR 150 TOP LATERAL SILVER (2,4m)	1	D

SLID PAR DUO CENTRAL			
Ref.	Beschreibung	Ein.	Bild.
3087	KIT SLID PAR 150 DUO CENTRAL SILVER (1,80m)	1	E
3088	KIT SLID PAR 150 DUO CENTRAL SILVER (2,40m)	1	E
3089	KIT SLID PAR 150 DUO CENTRAL SILVER (2,80m)	1	E
3090	KIT SLID PAR 150 DUO CENTRAL SILVER (3,40m)	1	E

SLID PAR DUO TOP CENTRAL			
Ref.	Beschreibung	Ein.	Bild.
3091	KIT SLID PAR 150 TOP DUO CENTRAL SILVER (1,80m)	1	F
3092	KIT SLID PAR 150 TOP DUO CENTRAL SILVER (2,40m)	1	F
3093	KIT SLID PAR 150 TOP DUO CENTRAL SILVER (2,80m)	1	F
3094	KIT SLID PAR 150 TOP DUO CENTRAL SILVER (3,40m)	1	F

SLID PAR DUO LATERAL			
Ref.	Beschreibung	Ein.	Bild.
2749	KIT SLID PAR 150 DUO LATERAL SILVER (4,00m)	1	F

SLID PAR TOP DUO LATERAL			
Ref.	Beschreibung	Ein.	Bild.
2755	KIT SLID PAR 150 TOP DUO LATERAL SILVER (4,00)	1	H

REFERENCIAS / REFERENCES / RÉFÉRENCES / REFERENZ



A



B



C



D



E

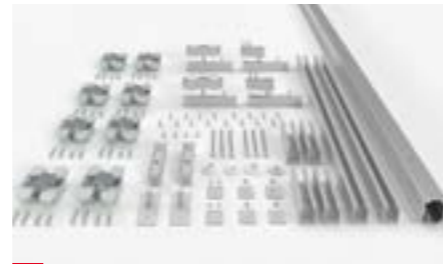

F



G

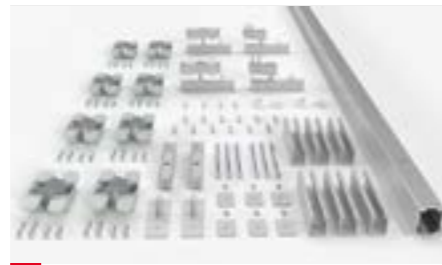

H

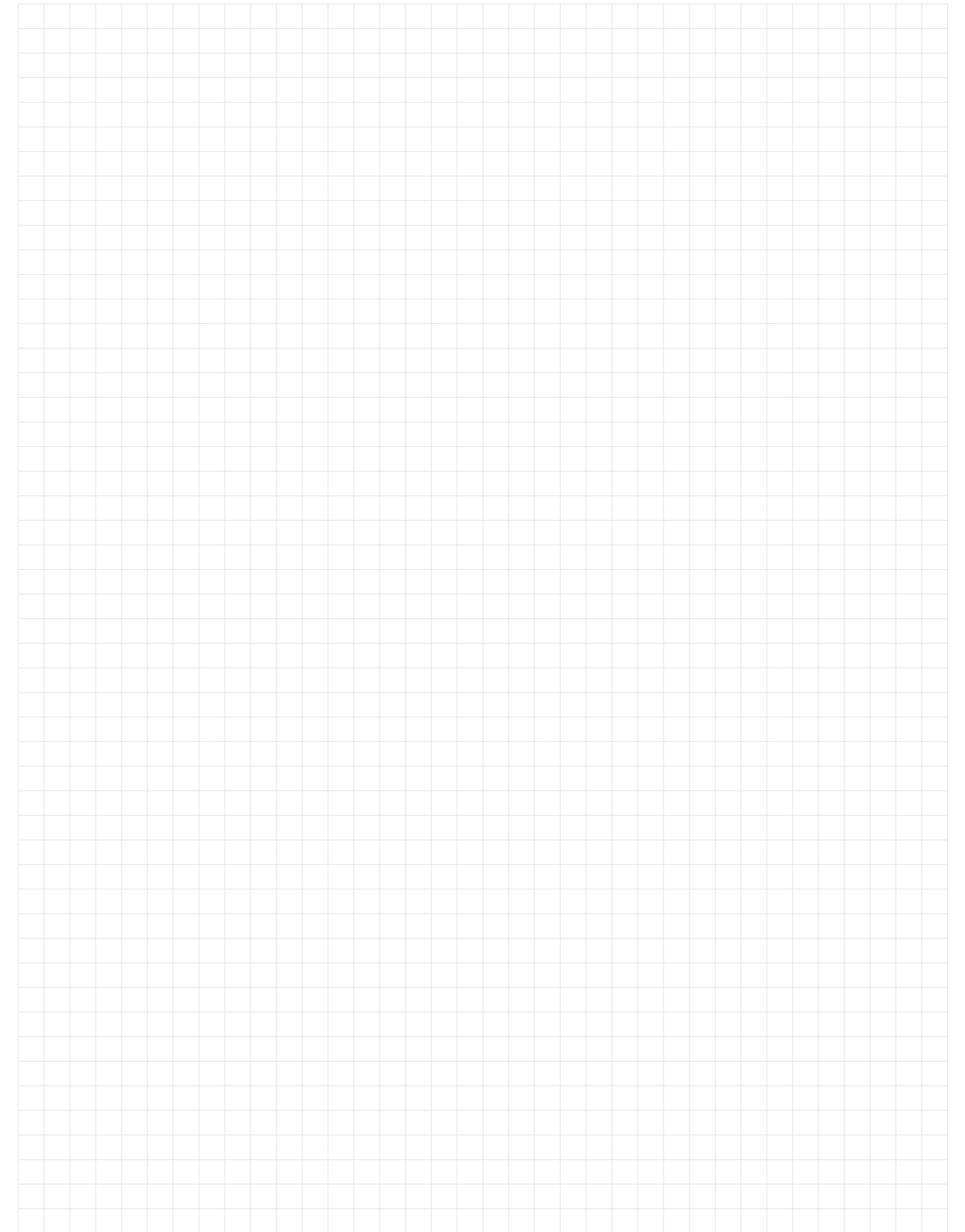

KLEIN®

KLEIN EUROPE
Edificio KLEIN
Polígono Industrial Can Cuyás
N-150 Km. 1
08110 Montcada i Reixac
Barcelona (Spain)

Tel.: +34 935 760 101
Fax: +34 935 760 109

+Info
klein@klein.es
www.klein.es

Síguenos en redes
Follow us on social media



Sistema de puertas plegables
Folding doors system
Système de portes pliables
Falttüren-System



SLID FOLD

Interiorismo Madera
Interior Design Wood
Décoration d'Intérieur Bois
Raumgestaltung Holz



SLID FOLD



ESP

SLID FOLD es un sistema para puertas plegables interiores diseñado para 3, 4 o 5 paneles plegables. Ofrece una máxima integración del perfil en el falso techo en su versión empotrada.

- Nuevas bisagras invisibles, integradas en el juego de accesorios para disponer de todos los elementos de la instalación.
- Dos tipos de plegado: central y lateral, para cumplir con cualquier reto arquitectónico.
- Perfil Top empotrable para instalaciones invisibles.
- Funcionamiento óptimo gracias al sistema de pivotación.
- Perfil inferior de dimensiones muy reducidas.
- Sistema Retrac: facilita el montaje del conjunto.
- Perfil de aluminio anodizado Silver.
- 5 paneles como máximo, con un total de 150 kg.
- Espesor de paneles a partir de 35 mm.
- 5 años de garantía.

Sistemas testados hasta 100.000 ciclos según la norma EN1527.

FRA

SLID FOLD est un système pour portes pliantes intérieures conçu pour 3, 4 ou 5 vantaux pliants. Dans sa version encastrée, il offre une intégration maximale du profil dans le faux plafond.

- Nouvelles charnières invisibles, intégrées dans le set d'accessoires pour disposer de tous les éléments d'installation.
- Deux types de pliage: central et latéral, pour répondre à tout défi architectural.
- Profil Top encastrable pour installations invisibles.
- Fonctionnement optimal grâce au système de pivotement.
- Rail inférieur de dimensions réduites.
- Système Retrac: facilite le montage de l'ensemble.
- Profil en aluminium anodisé Silver.
- 5 panneaux, au maximum, avec un poids total de 150 kg.
- Épaisseur du plateau à partir de 35 mm.
- Garantie KLEIN® 5 ans.

Systèmes testés jusqu'à 100.000 cycles selon la norme EN1527.

ENG

SLID FOLD is an interior folding door system designed to fit in openings through 3, 4 or 5 folding panels. It guarantees maximum architectural integration when the track is recessed.

- New invisible hinges, integrated in the accessory set to have all installation elements.
- Two types of folding: central and side, to meet any architectural challenge.
- Recessed track (Top) for invisible installations.
- Optimum functionality through pivot system.
- Reduced dimension of the bottom track.
- Retrac system facilitates the installation of the set.
- Anodized silver aluminum surface.
- Up to 5 panels, maximum of 150 kg in total.
- Panel thickness from 35 mm.
- 5 year warranty.

Systems tested up to 100.000 cycles as per standard EN1527.

DEU

SLID FOLD ist ein System für Falttüren in Innenräumen, das sich für 3, 4 oder 5 Faltpaneele eignet. In der Einbauausführung integriert sich das Profil maximal in die Zwischendecke.

- Neue unsichtbare Scharniere, die in den Zubehörsatz integriert sind, um alle Installationselemente zu haben.
- Twee soorten vouwen: centraal en opzij, om elke architecturale uitdaging aan te gaan.
- Einbaubares Profil Top für den unsichtbaren Einbau.
- Optimale Funktion durch das Schwenksystem.
- Untere Profile sehr klein.
- Das System Retrac vereinfacht die Montage der Baugruppe.
- Profil aus eloxiertem Aluminium in "Silver".
- Höchstens 5 Paneele, mit einem Gesamtgewicht von 150 kg.
- Pfannendicke ab 35 mm.
- Garantie von KLEIN® 5 Jahre.

Systeme gemäß der Norm EN1527 bis 100.000 Zyklen getestet.

SLID FOLD

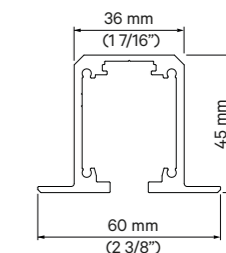
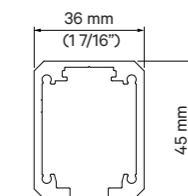
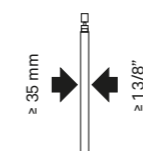

PLEGADO LATERAL/ SIDE FOLDING
SEITLICH FALTUNG / PLIAGE LATÉRAL

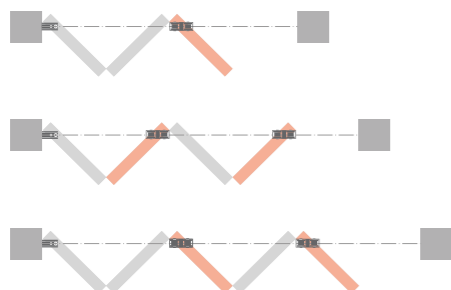

Roller situado en el panel marcado en rojo/ Roller located in the panel marked in red

PLEGADO CENTRAL/ CENTRAL FOLDING
ZENTRAL FALTUNG / PLIAGE CENTRAL

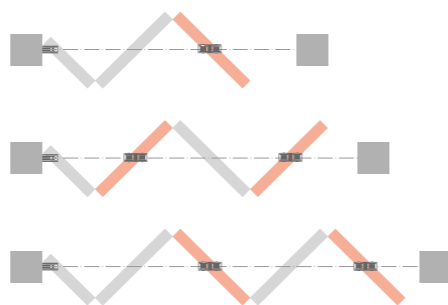

INSTALACIÓN VISTA/
EXPOSED INSTALLATION

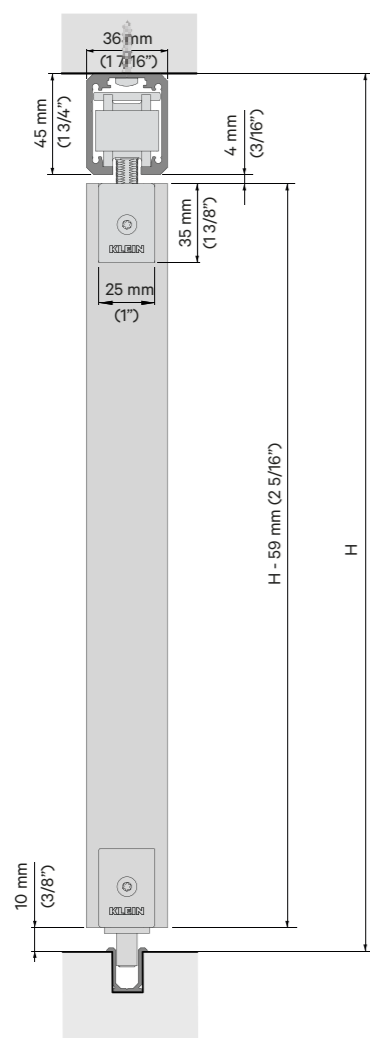

INSTALACIÓN EMPOTRADA
RECESSED INSTALLATION

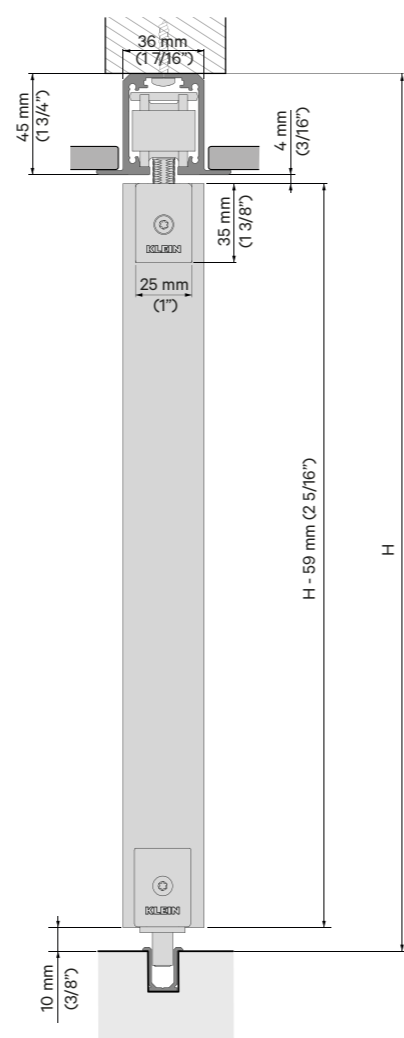

SLID FOLD LATERAL

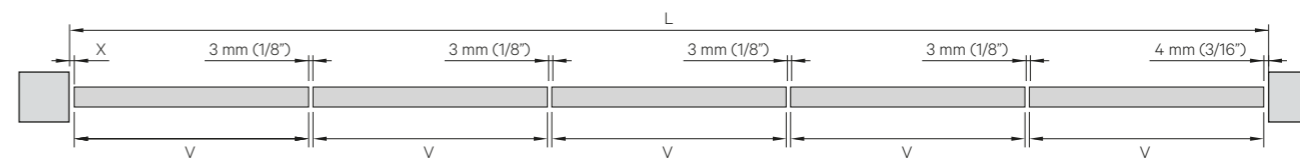
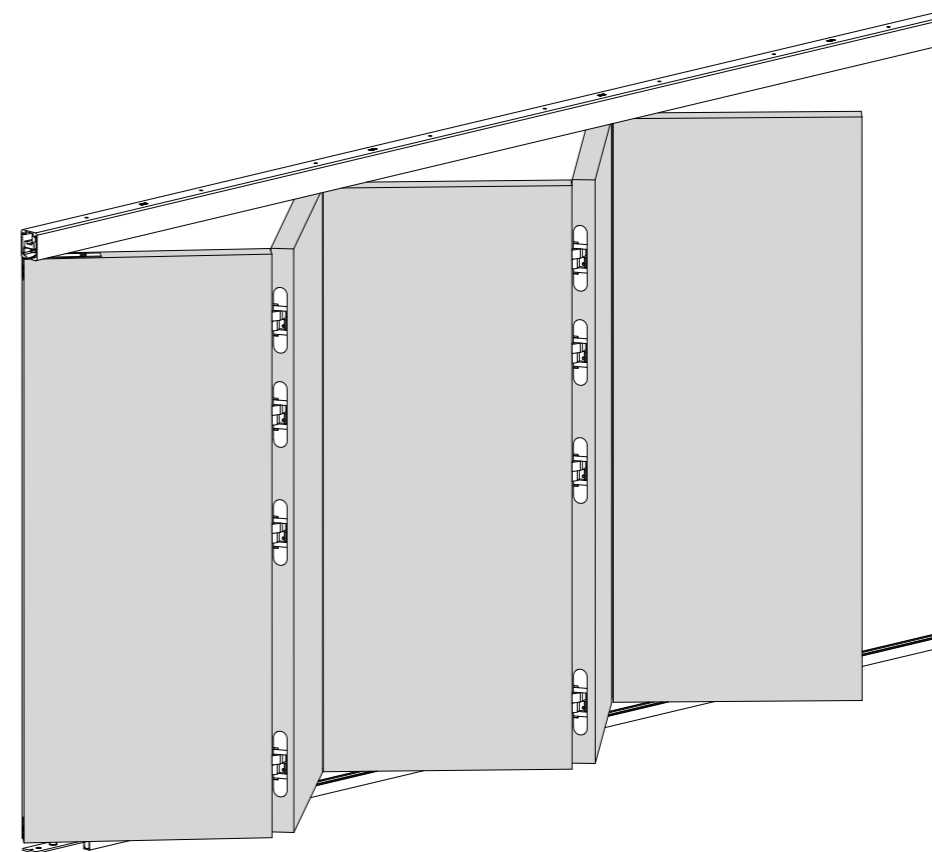

$$L - X - 4 \text{ mm } (3/16'') - ((N - 1) \times 3 \text{ mm } (1/8''))$$

V Min. = 350 mm (13 13/16'')

V Max. = 1000 mm (3' 3 3/8'')

Espesor Puerta (Panel Thickness)	X
35 mm (1 3/8'')	5 mm (3/16'')
40 mm (1 9/16'')	6 mm (1/4'')
45 mm (1 3/4'')	7 mm (9/32'')
50 mm (2'')	8 mm (5/16'')

N = Número de hojas (Number of panels)

SLID FOLD CENTRAL

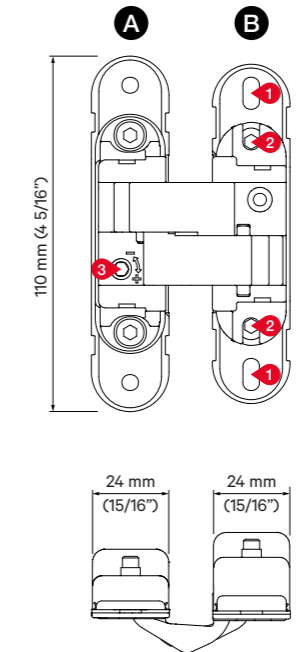
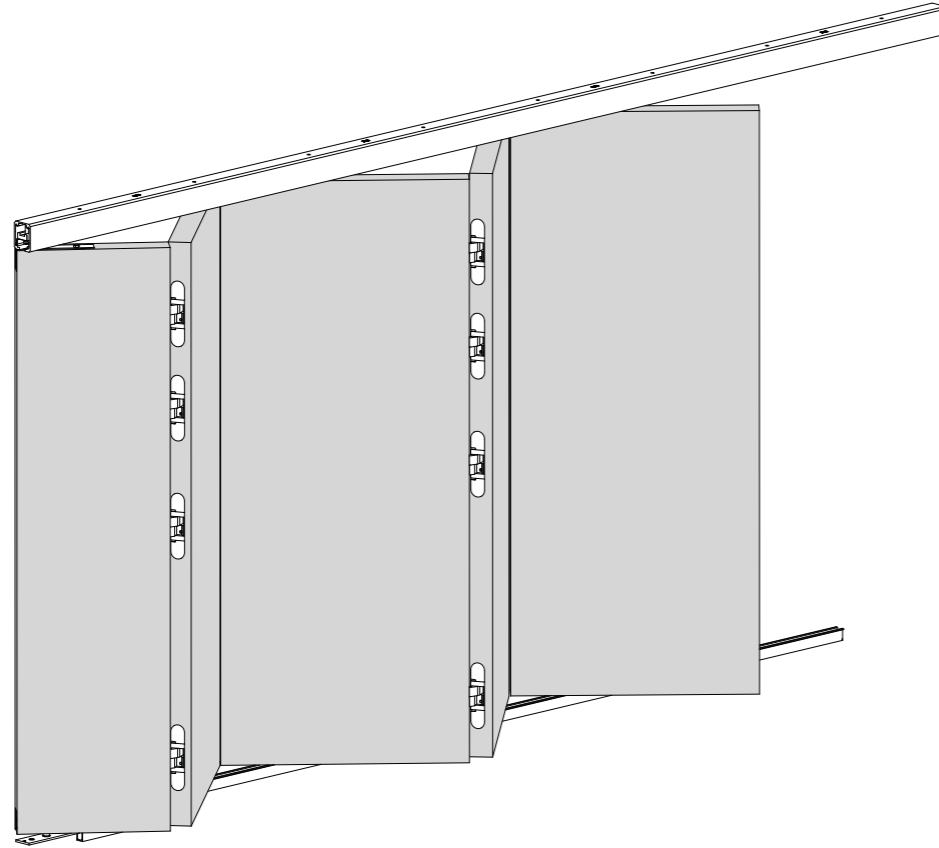

- Regulación 3D**
- 1 Vertical: ± 2,5 mm (1/8")
 - 2 Horizontal: ± 1,5 mm (1/16")
 - 3 Profundidad: ± 1 mm (3/64")

MECANIZACIÓN DEL PANEL/
PANEL FABRICATION

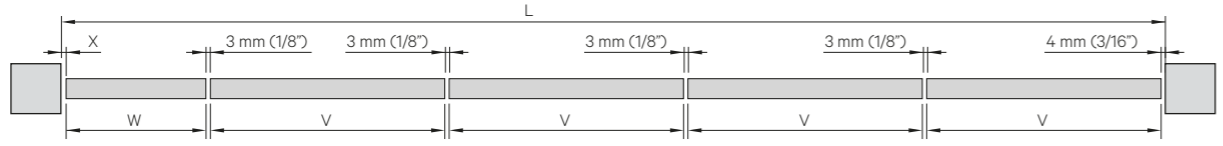

$$V = \frac{L - (51 \text{ mm} + X) - ((N-1) \times 3 \text{ mm})}{(N-0,5)} \quad W = \frac{V}{2} + 51 \text{ mm}$$

$$V = \frac{L - (2" + X) - ((N-1) \times 1/8")}{(N-0,5)} \quad W = \frac{V}{2} + 2"$$

V Min. = 350 mm (13 13/16")
V Max. = 1000 mm (3' 3 3/8")

Espeor Puerta (Panel Thickness)	X
35 mm (1 3/8")	5 mm (3/16")
40 mm (1 9/16")	6 mm (1/4")
45 mm (1 3/4")	7 mm (9/32")
50 mm (2")	8 mm (5/16")

N = Número de hojas (Number of panels)

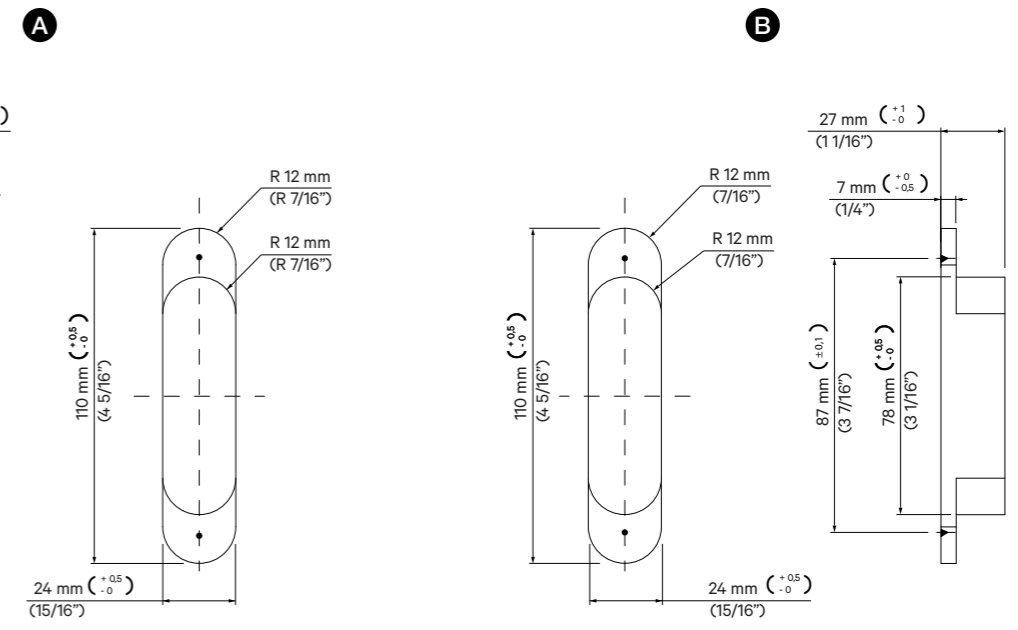

SSLID FOLD LATERAL			
Ref.	Description	Unités	Img.
2766	KIT SLID FOLD 150 LATERAL 3 PANNEAUX SILVER (1,80m)	1	G
2767	KIT SLID FOLD 150 LATERAL 3 PANNEAUX SILVER (2,40m)	1	G
2768	KIT SLID FOLD 150 LATERAL 3 PANNEAUX SILVER (2,80m)	1	G
2684	KIT SLID FOLD 150 LATERAL 3 PANNEAUX SILVER (3,40m)	1	H
3037	KIT SLID FOLD 150 LATERAL 4 PANNEAUX SILVER (1,80m)	1	H
2769	KIT SLID FOLD 150 LATERAL 4 PANNEAUX SILVER (2,40m)	1	H
2770	KIT SLID FOLD 150 LATERAL 4 PANNEAUX SILVER (2,80m)	1	H
2771	KIT SLID FOLD 150 LATERAL 4 PANNEAUX SILVER (3,40m)	1	H
2772	KIT SLID FOLD 150 LATERAL 4 PANNEAUX SILVER (4,00m)	1	I
3099	KIT SLID FOLD 150 LATERAL 5 PANNEAUX SILVER (1,80M)	1	I
3101	KIT SLID FOLD 150 LATERAL 5 PANNEAUX SILVER (2,40m)	1	I
3026	KIT SLID FOLD 150 LATERAL 5 PANNEAUX SILVER (2,80m)	1	I
3027	KIT SLID FOLD 150 LATERAL 5 PANNEAUX SILVER (3,40m)	1	I
3028	KIT SLID FOLD 150 LATERAL 5 PANNEAUX SILVER (4,00m)	1	I
3011	KIT SLID FOLD 150 LATERAL 5 PANNEAUX SILVER (6,00m)	1	I

SLID FOLD TOP LATERAL			
Ref.	Description	Unités	Img.
2776	KIT SLID FOLD 150 TOP LATERAL 3 PANNEAUX SILVER (1,80m)	1	J
2777	KIT SLID FOLD 150 TOP LATERAL 3 PANNEAUX SILVER (2,40m)	1	J
2778	KIT SLID FOLD 150 TOP LATERAL 3 PANNEAUX SILVER (2,80m)	1	J
3047	KIT SLID FOLD 150 TOP LATERAL 3 PANNEAUX SILVER (3,40m)	1	K
1783	KIT SLID FOLD 150 TOP LATERAL 4 PANNEAUX SILVER (1,80m)	1	K
2779	KIT SLID FOLD 150 TOP LATERAL 4 PANNEAUX SILVER (2,40m)	1	K
2780	KIT SLID FOLD 150 TOP LATERAL 4 PANNEAUX SILVER (2,80m)	1	K
2781	KIT SLID FOLD 150 TOP LATERAL 4 PANNEAUX SILVER (3,40m)	1	K
2782	KIT SLID FOLD 150 TOP LATERAL 4 PANNEAUX SILVER (4,00m)	1	L
3049	KIT SLID FOLD 150 TOP LATERAL 5 PANNEAUX SILVER (1,80m)	1	L
3050	KIT SLID FOLD 150 TOP LATERAL 5 PANNEAUX SILVER (2,40m)	1	L
3051	KIT SLID FOLD 150 TOP LATERAL 5 PANNEAUX SILVER (2,80m)	1	L
3052	KIT SLID FOLD 150 TOP LATERAL 5 PANNEAUX SILVER (3,40m)	1	L
3053	KIT SLID FOLD 150 TOP LATERAL 5 PANNEAUX SILVER (4,00m)	1	L
3012	KIT SLID FOLD 150 TOP LATERAL 5 PANNEAUX SILVER (6,00m)	1	L

SLID FOLD LATERAL			
Ref.	Beschreibung	Ein.	Bild.
2766	KIT SLID FOLD 150 LATERAL 3 PANEEL SILVER (1,80m)	1	G
2767	KIT SLID FOLD 150 LATERAL 3 PANEEL SILVER (2,40m)	1	G
2768	KIT SLID FOLD 150 LATERAL 3 PANEEL SILVER (2,80m)	1	G
2684	KIT SLID FOLD 150 LATERAL 3 PANEEL SILVER (3,40m)	1	H
3037	KIT SLID FOLD 150 LATERAL 4 PANEEL SILVER (1,80m)	1	H
2769	KIT SLID FOLD 150 LATERAL 4 PANEEL SILVER (2,40m)	1	H
2770	KIT SLID FOLD 150 LATERAL 4 PANEEL SILVER (2,80m)	1	H
2771	KIT SLID FOLD 150 LATERAL 4 PANEEL SILVER (3,40m)	1	H
2772	KIT SLID FOLD 150 LATERAL 4 PANEEL SILVER (4,00m)	1	I
3099	KIT SLID FOLD 150 LATERAL 5 PANEEL SILVER (1,80M)	1	I
3101	KIT SLID FOLD 150 LATERAL 5 PANEEL SILVER (2,40m)	1	I
3026	KIT SLID FOLD 150 LATERAL 5 PANEEL SILVER (2,80m)	1	I
3027	KIT SLID FOLD 150 LATERAL 5 PANEEL SILVER (3,40m)	1	I
3028	KIT SLID FOLD 150 LATERAL 5 PANEEL SILVER (4,00m)	1	I
3011	KIT SLID FOLD 150 LATERAL 5 PANEEL SILVER (6,00m)	1	I

SLID FOLD TOP LATERAL			
Ref.	Beschreibung	Ein.	Bild.
2776	KIT SLID FOLD 150 TOP LATERAL 3 PANEEL SILVER (1,80m)	1	J
2777	KIT SLID FOLD 150 TOP LATERAL 3 PANEEL SILVER (2,40m)	1	J
2778	KIT SLID FOLD 150 TOP LATERAL 3 PANEEL SILVER (2,80m)	1	J
3047	KIT SLID FOLD 150 TOP LATERAL 3 PANEEL SILVER (3,40m)	1	K
1783	KIT SLID FOLD 150 TOP LATERAL 4 PANEEL SILVER (1,80m)	1	K
2779	KIT SLID FOLD 150 TOP LATERAL 4 PANEEL SILVER (2,40m)	1	K
2780	KIT SLID FOLD 150 TOP LATERAL 4 PANEEL SILVER (2,80m)	1	K
2781	KIT SLID FOLD 150 TOP LATERAL 4 PANEEL SILVER (3,40m)	1	K
2782	KIT SLID FOLD 150 TOP LATERAL 4 PANEEL SILVER (4,00m)	1	L
3049	KIT SLID FOLD 150 TOP LATERAL 5 PANEEL SILVER (1,80m)	1	L
3050	KIT SLID FOLD 150 TOP LATERAL 5 PANEEL SILVER (2,40m)	1	L
3051	KIT SLID FOLD 150 TOP LATERAL 5 PANEEL SILVER (2,80m)	1	L
3052	KIT SLID FOLD 150 TOP LATERAL 5 PANEEL SILVER (3,40m)	1	L
3053	KIT SLID FOLD 150 TOP LATERAL 5 PANEEL SILVER (4,00m)	1	L
3012	KIT SLID FOLD 150 TOP LATERAL 5 PANEEL SILVER (6,00m)	1	L

DEU

SLID FOLD CENTRAL			
Ref.	Beschreibung	Ein.	Bild.
2786	KIT SLID FOLD 150 CENTRAL 3 PANEEL SILVER (1,80m)	1	A
2787	KIT SLID FOLD 150 CENTRAL 3 PANEEL SILVER (2,40m)	1	A
3022	KIT SLID FOLD 150 CENTRAL 3 PANEEL SILVER (2,80m)	1	A
2899	KIT SLID FOLD 150 CENTRAL 4 PANEEL SILVER (1,80m)	1	B
2788	KIT SLID FOLD 150 CENTRAL 4 PANEEL SILVER (2,40m)	1	B
2789	KIT SLID FOLD 150 CENTRAL 4 PANEEL SILVER (2,80m)	1	B
2798	KIT SLID FOLD 150 CENTRAL 4 PANEEL SILVER (3,40m)	1	B
2799	KIT SLID FOLD 150 CENTRAL 4 PANEEL SILVER (4,00m)	1	B
2666	KIT SLID FOLD 150 CENTRAL 5 PANEEL SILVER (2,40m)	1	C
2667	KIT SLID FOLD 150 CENTRAL 5 PANEEL SILVER (2,80M)	1	C
2668	KIT SLID FOLD 150 CENTRAL 5 PANEEL SILVER (3,40m)	1	C
2669	KIT SLID FOLD 150 CENTRAL 5 PANEEL SILVER (4,00m)	1	C
3015	KIT SLID FOLD 150 CENTRAL 5 PANEEL SILVER (6,00m)	1	C

SLID FOLD TOP CENTRAL			
Ref.	Beschreibung	Ein.	Bild.
2885	KIT SLID FOLD 150 TOP CENTRAL 3 PANEEL SILVER (1,80m)	1	D
2887	KIT SLID FOLD 150 TOP CENTRAL 3 PANEEL SILVER (2,40m)	1	D
3024	KIT SLID FOLD 150 TOP CENTRAL 3 PANEEL SILVER (2,80m)	1	D
3039	KIT SLID FOLD 150 TOP CENTRAL 4 PANEEL SILVER (1,80m)	1	E
2888	KIT SLID FOLD 150 TOP CENTRAL 4 PANEEL SILVER (2,40m)	1	E
2889	KIT SLID FOLD 150 TOP CENTRAL 4 PANEEL SILVER (2,80m)	1	E
2894	KIT SLID FOLD 150 TOP CENTRAL 4 PANEEL SILVER (3,40m)	1	E
2898	KIT SLID FOLD 150 TOP CENTRAL 4 PANEEL SILVER (4,00m)	1	E
2610	KIT SLID FOLD 150 TOP CENTRAL 5 PANEEL SILVER (2,40m)	1	F
2614	KIT SLID FOLD 150 TOP CENTRAL 5 PANEEL SILVER (2,80m)	1	F
2615	KIT SLID FOLD 150 TOP CENTRAL 5 PANEEL SILVER (3,40m)	1	F
2619	KIT SLID FOLD 150 TOP CENTRAL 5 PANEEL SILVER (4,00m)	1	F
3021	KIT SLID FOLD 150 TOP CENTRAL 5 PANEEL SILVER (6,00m)	1	F

REFERENCIAS / REFERENCES / RÉFÉRENCES / REFERENZ

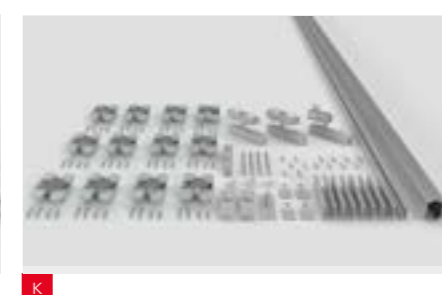
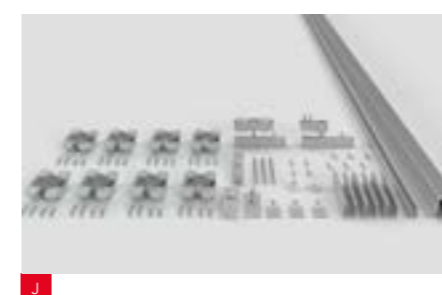
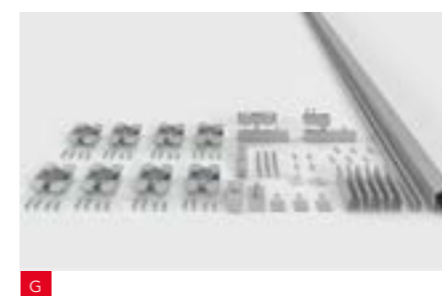
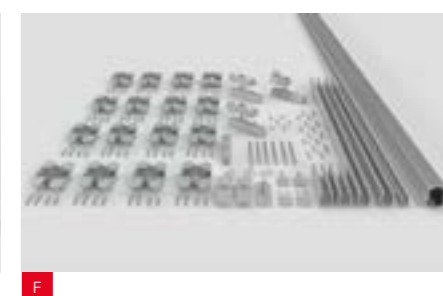
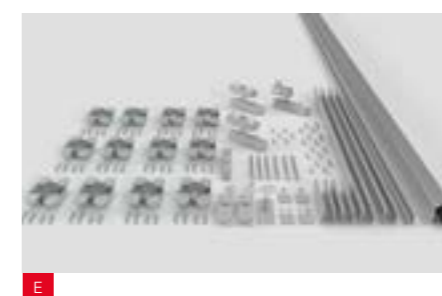
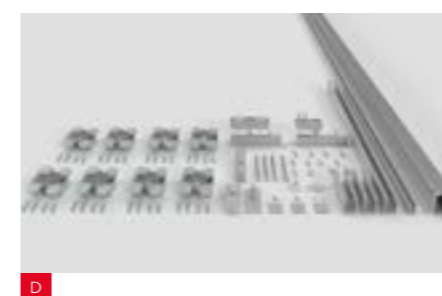
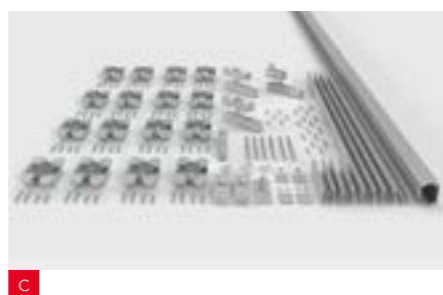
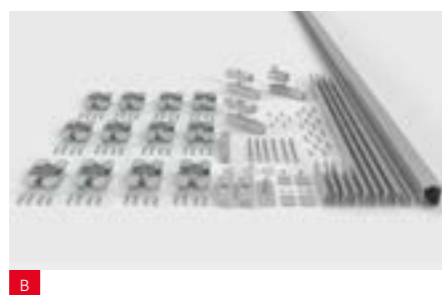
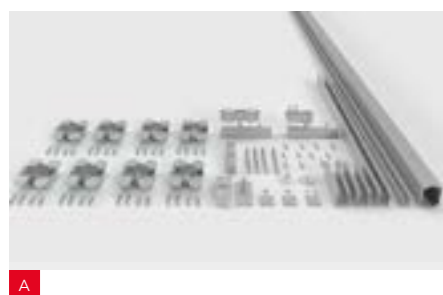

KLEIN®

KLEIN EUROPE
Edificio KLEIN
Polígono Industrial Can Cuyás
N-150 Km. 1
08110 Montcada i Reixac
Barcelona (Spain)

Tel.: +34 935 760 101
Fax: +34 935 760 109

+Info
klein@klein.es
www.klein.es

Síguenos en redes
Follow us on social media

